



Legend

- Keel plank, stern- and stem hooks, stern- and stemposts, keelson and riders
- Bottom planks
- Planking of the sides, repair plank
- Frames
- Detached timbers
- Cross-cut wood
- Broken-off frame top
- Peet
- Find number

Field drawing

The Nijkerk-II cog wreck with all detached parts in situ (yellow), the ceiling boards (pink), the frames (white), the planking of the sides (ochre), the bottom planks (light brown), the keelson, the riders, the keel plank, and the stern and stem (dark brown).

Scale

0 m 1 m

A. General view

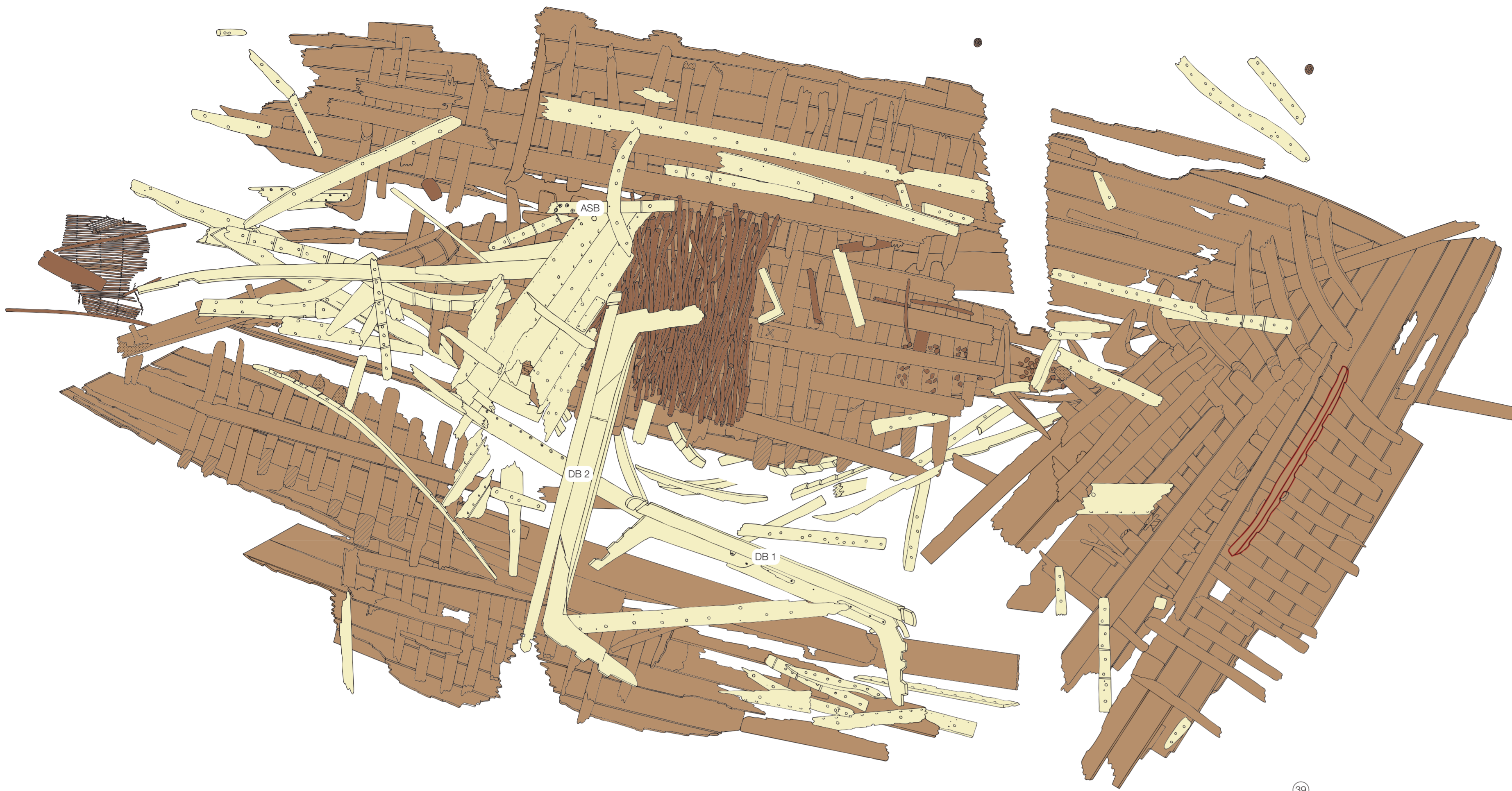

B. General view

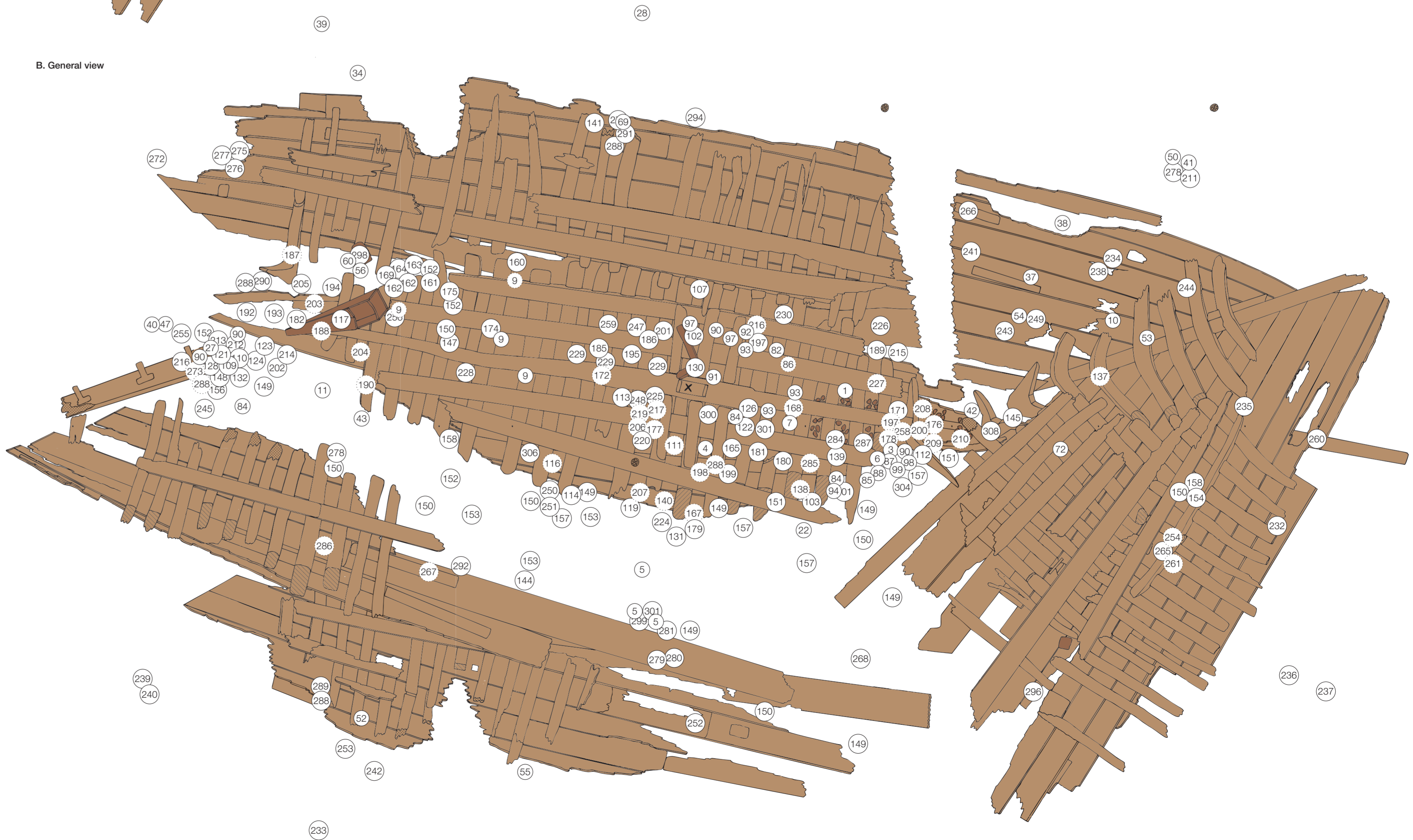

- Legend to A**
- Still joined-up timbers
 - Detached ship's timbers
 - Cross-cut wood
 - Broken-off frame
 - *Keelpnet, brushwood floor, kilick, ballast(?) stones, poles
 - Later addition of shelf clamb
 - Sternpost
 - Crossbeam

- Legend to B**
- Still joined-up timbers
 - Knee, drain, hewn-off head of crossbeam
 - Cross-cut wood
 - Broken-off frame top
 - Ballast(?) stones
 - Findspot and find number
 - Poles

Field drawings

A. The wreck including the detached timbers.

B. The wreck without the detached timbers, and distribution of the finds.

Scale

0 m 1 m 2 m

A. Bottom with scarfs

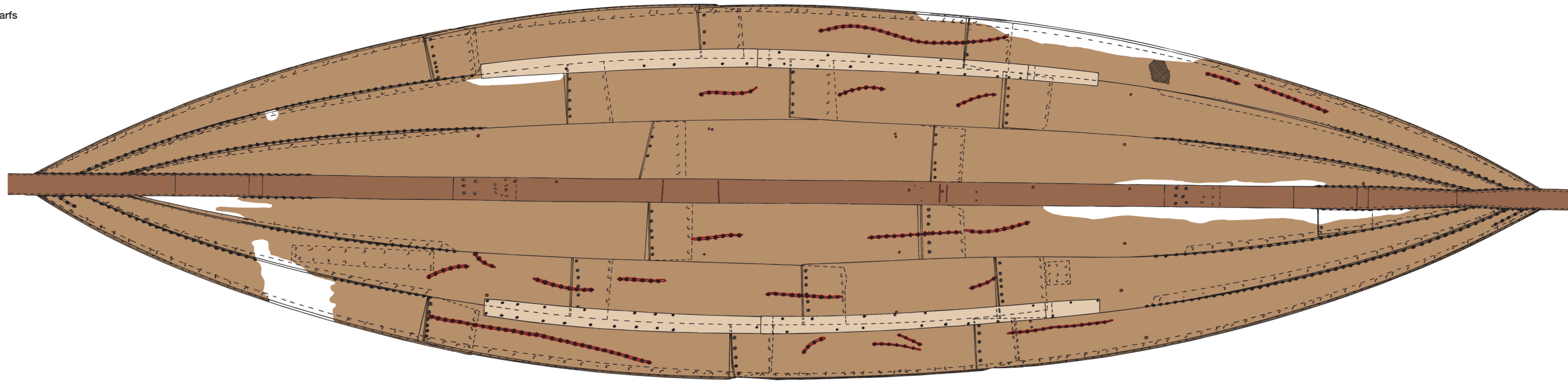

B. Inside view of the starboard side

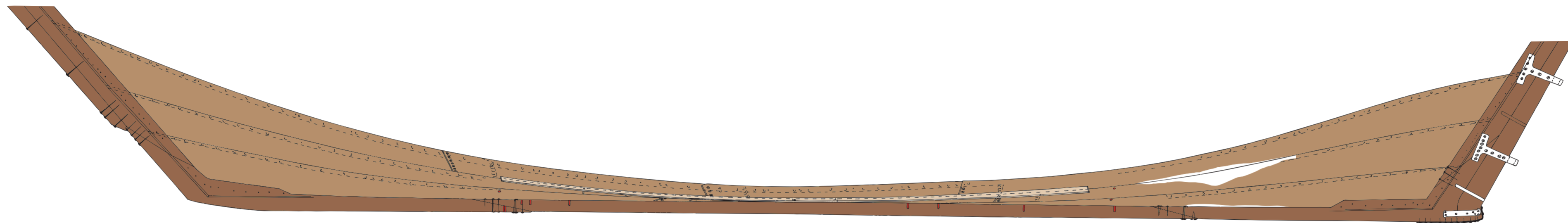

C. Top view

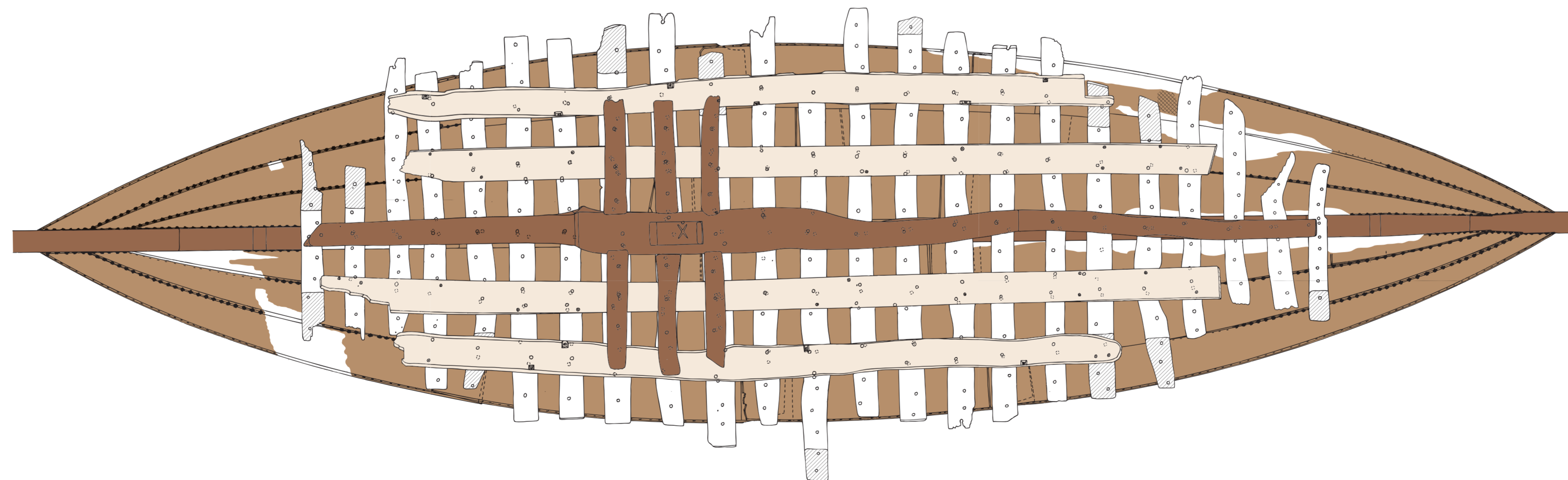

29 26/25½ 19 17 10 2 -1

Legend

- Keel plank, stem- and stern hooks, false stern and false stem
- Bottom planking
- Ceiling boards, bilge planks
- Frames, missing parts of the shell
- Cross-cut wood, scarf joints to futtocks
- Frame number
- Clamped moss caulking, imprints of shtel clamps
- Clamped moss caulking in cracks on the outside of the shell
- Abraded area at the foot of the pump barrel
- Nail-hole plugs remaining from temporary frames, and marks in the top of the keel plank relating to measurement during construction
- Lands in the clinker-built construction with double-clenched nails
- Repair planks on the outside of the shell

Field drawings

- A. The bottom strakes with their scarfs, the locations of the four temporary frames and connecting planks used at the start of construction (in red: treenails/nailhole plugs, large and small); the transition from carvel-to clinker-built shell construction; and the (caulked) repairs on the exterior, applied during the final phase of construction.
- B. Interior of the starboard part of the bottom.
- C. Top view of the bottom with the stem- and stern hooks and lower ends of the stem- and stemposts, all the floor timbers of construction phases 1- 4, the keelson, the A and B ceiling strakes and the six riders.

Scale

0 m 1 m

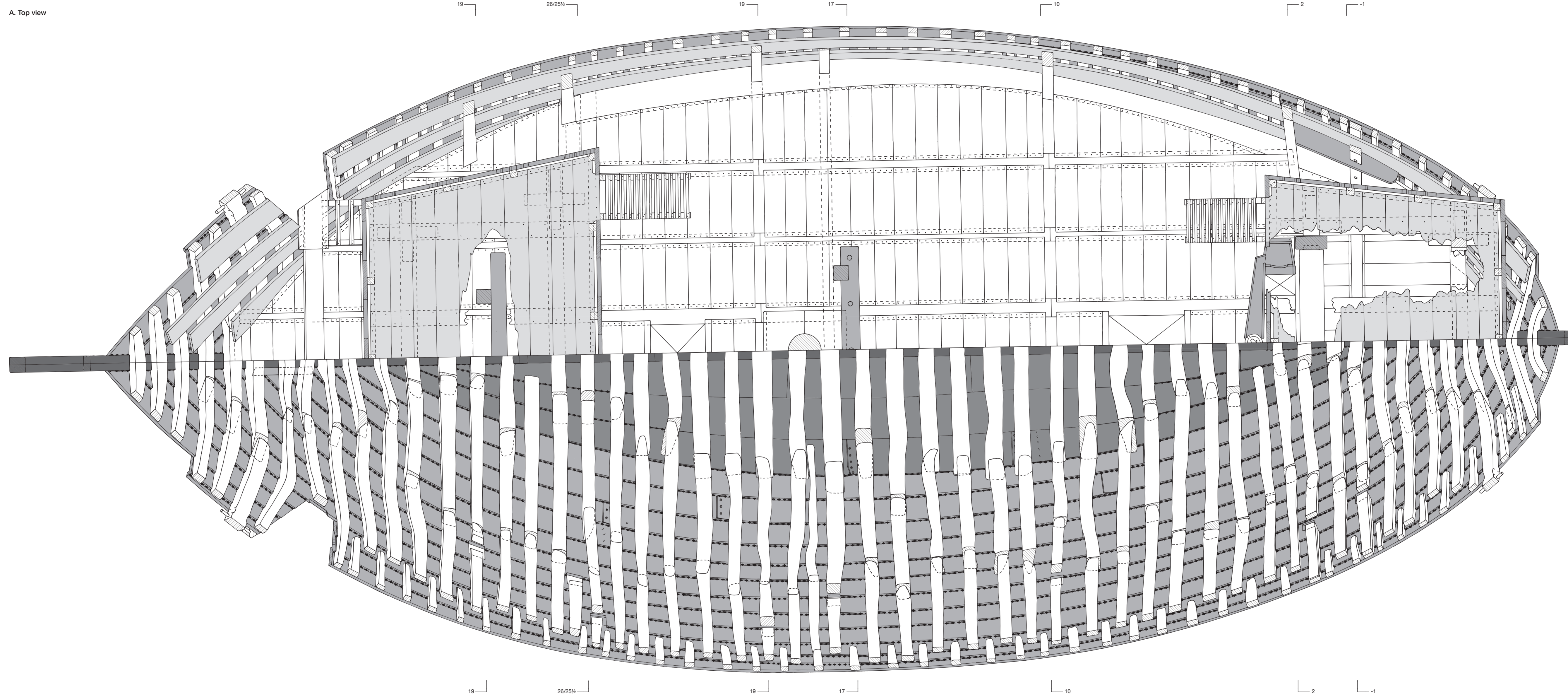

A. Top view

- Legend**
- Keel plank, stern- and stem hooks, stern- and stemposts, false stem
 - Bottom planking
 - Side planking, repair planks on the shell, windlasses, belaying rack, drain, sides of the castles
 - Ceiling boards, deck planks of the castles
 - Frames, deck beams, crossbeams, crossbeam knees, connecting beams, stringers, deck planks, mast partner, mast, stanchions supporting the castles, pump barrel
 - ▨ Cross-cut wood
 - Clamped moss caulking
 - Frame number

Reconstruction drawing

A. Deck plan with castles (starboard) and frames (port).

Scale

0 m 1 m

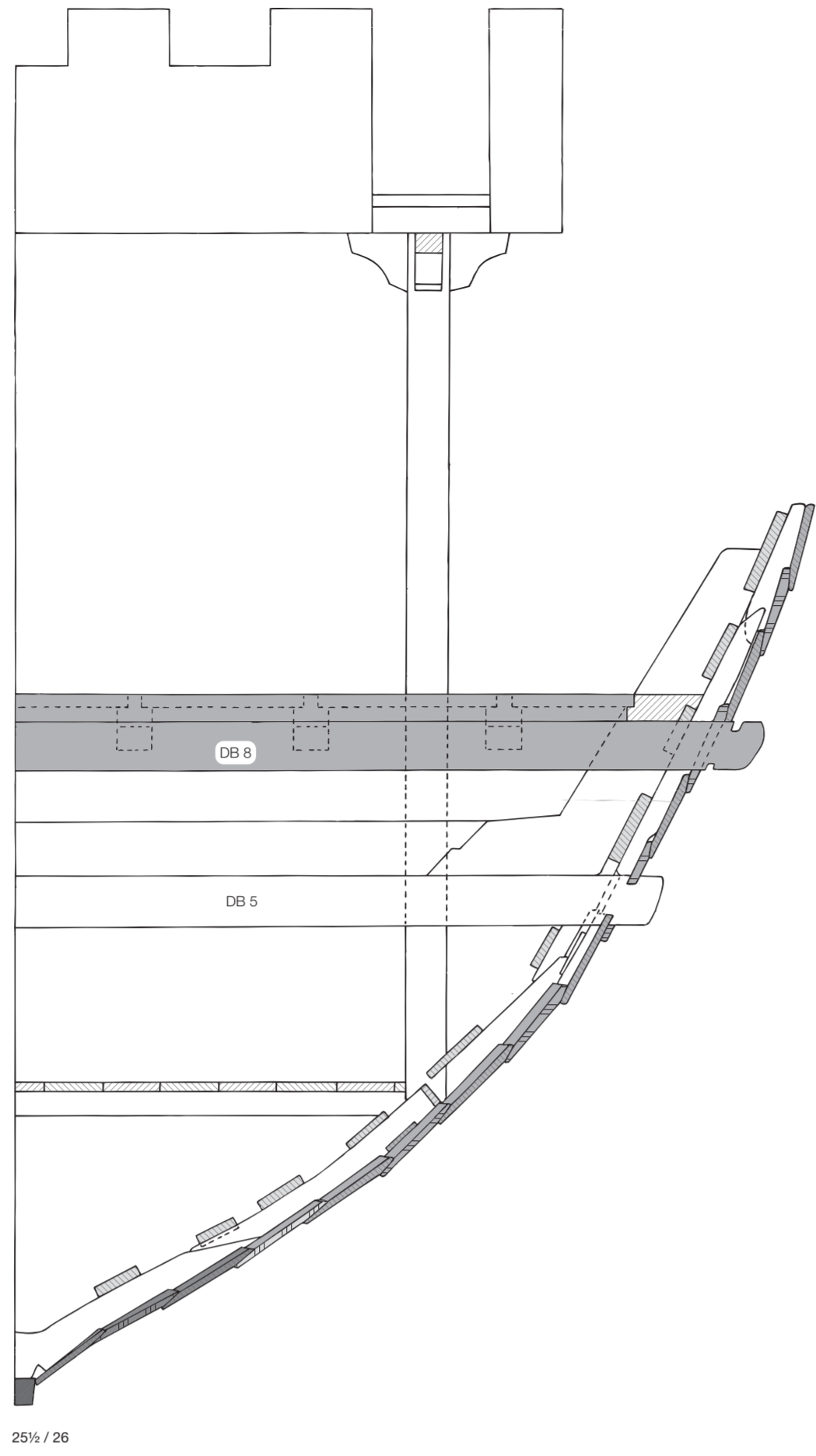
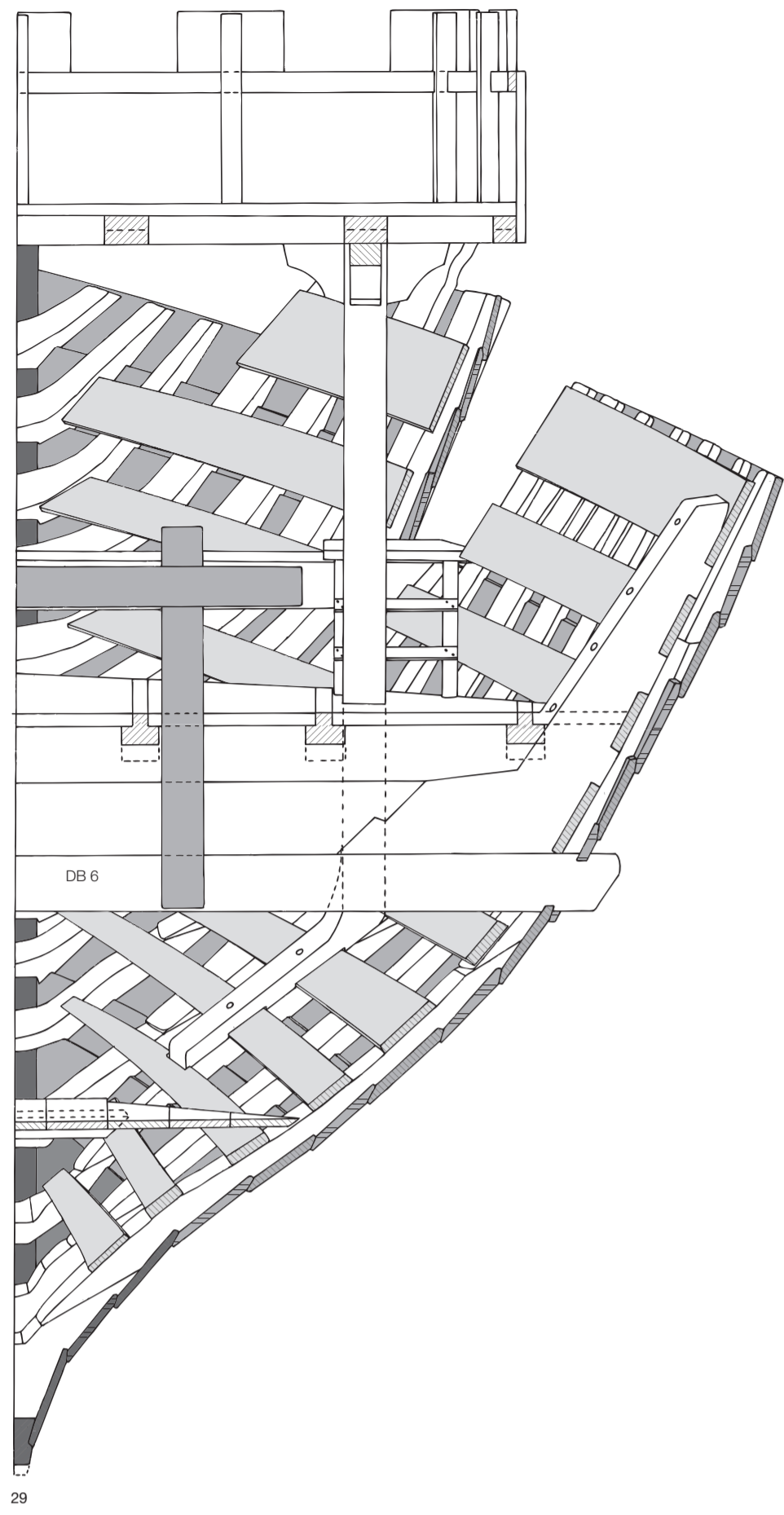

B. Cross-sections

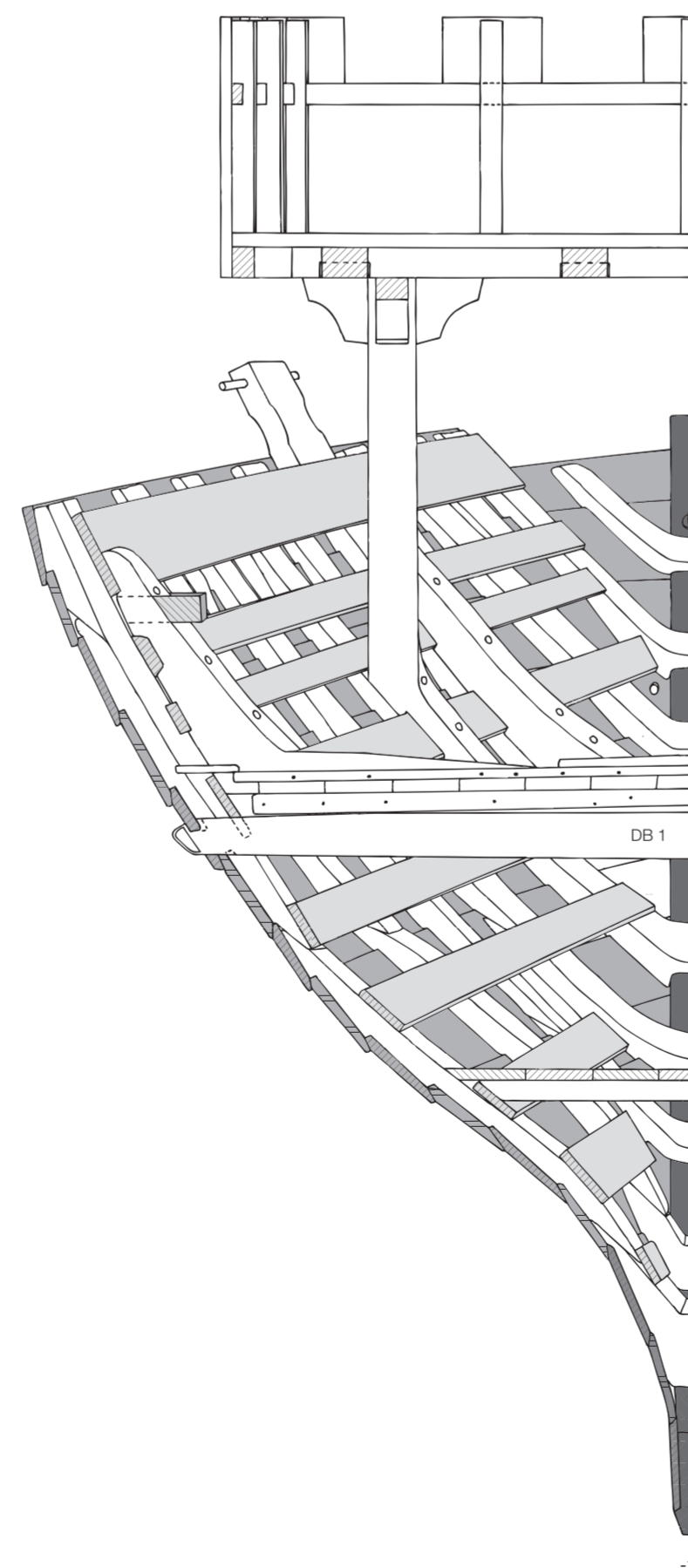
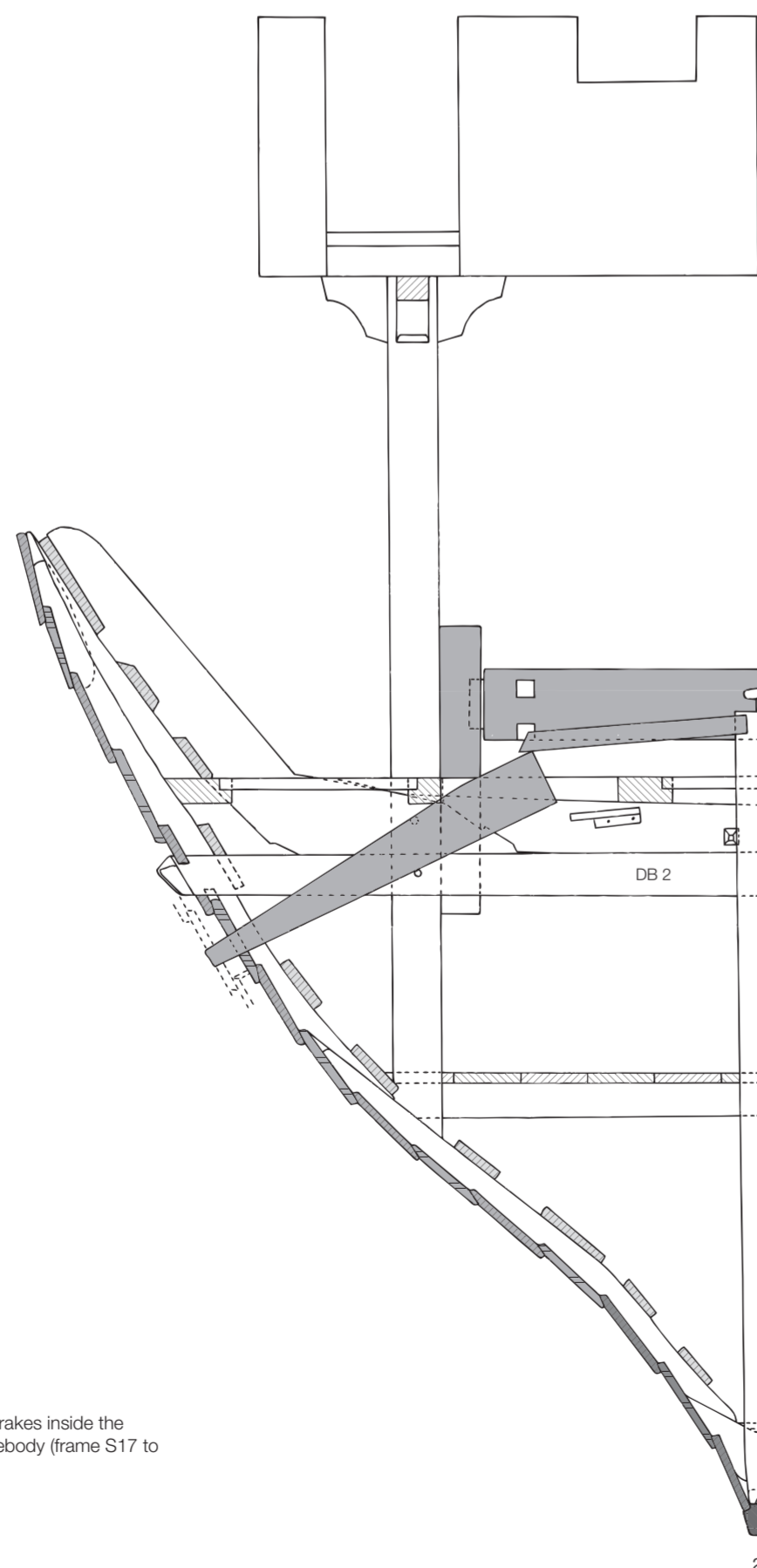
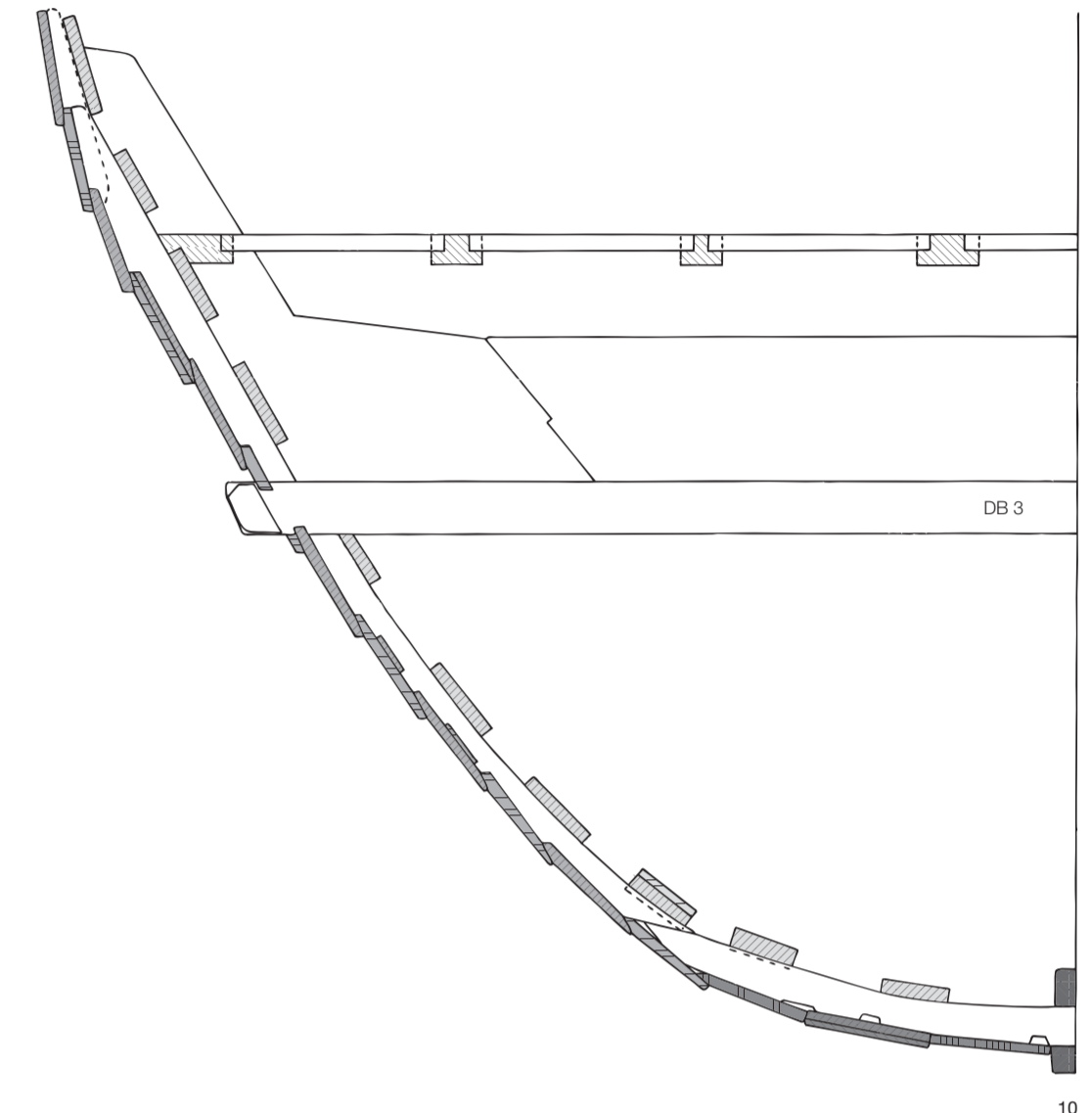
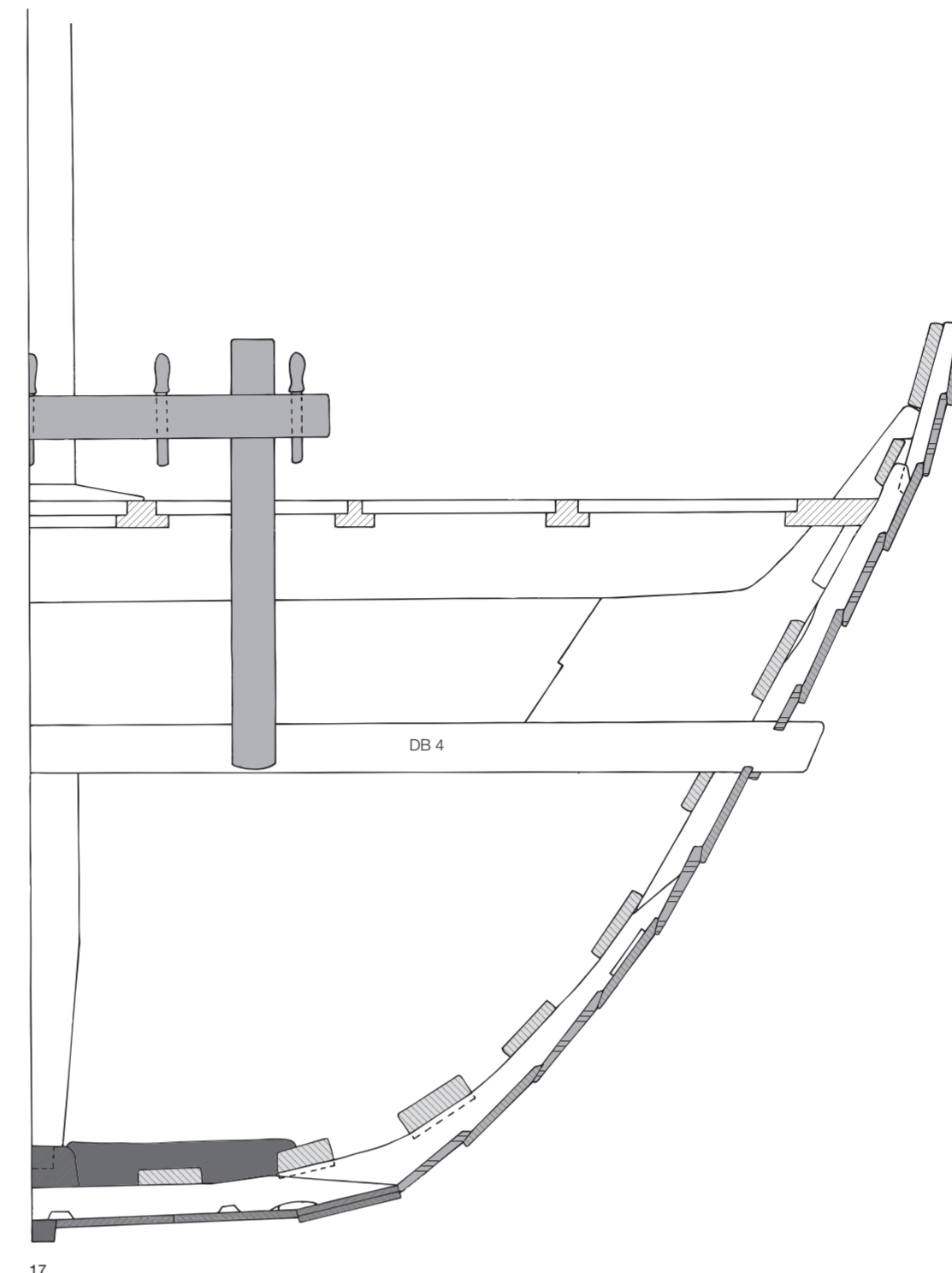
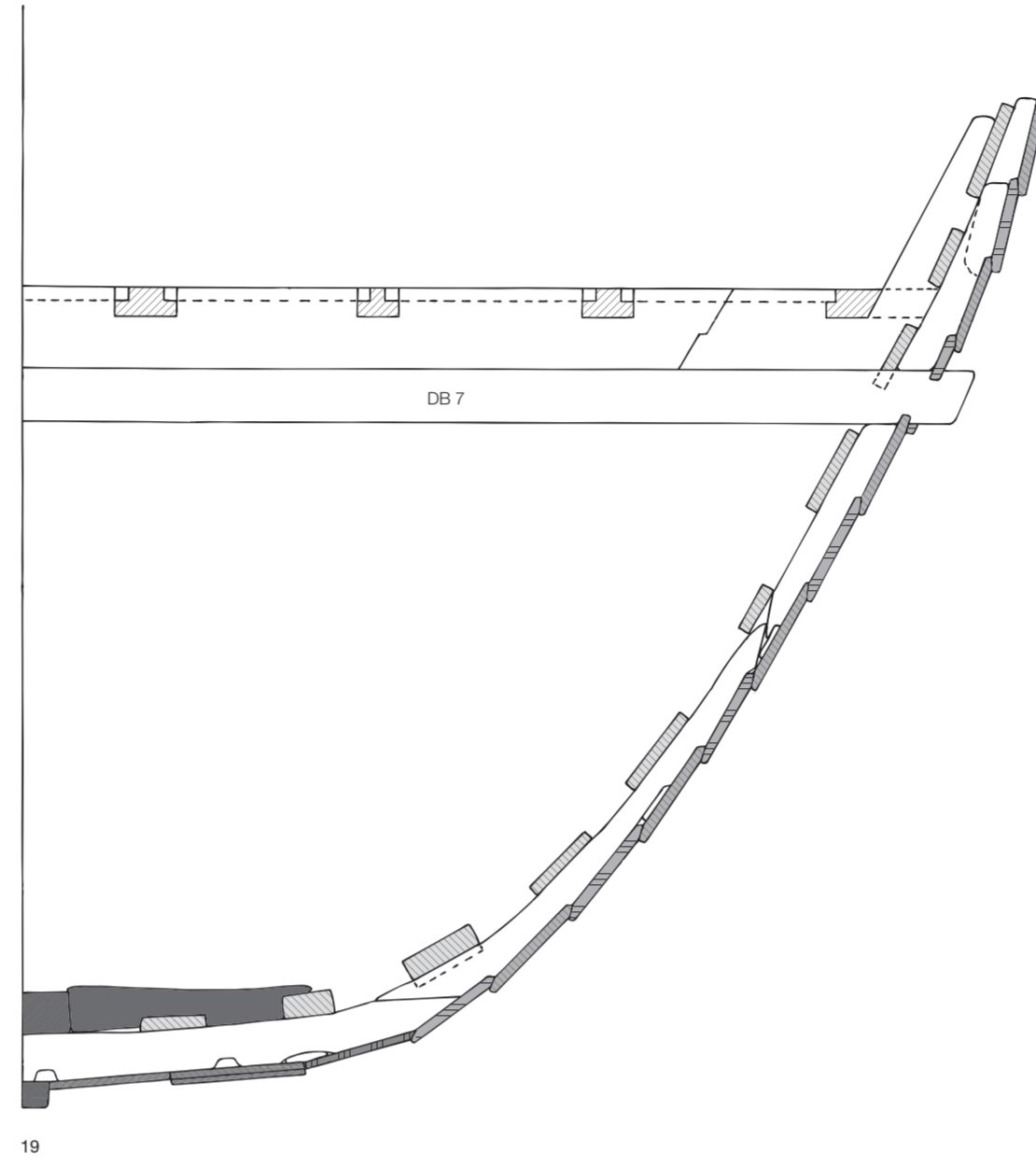

C. Planking drawing

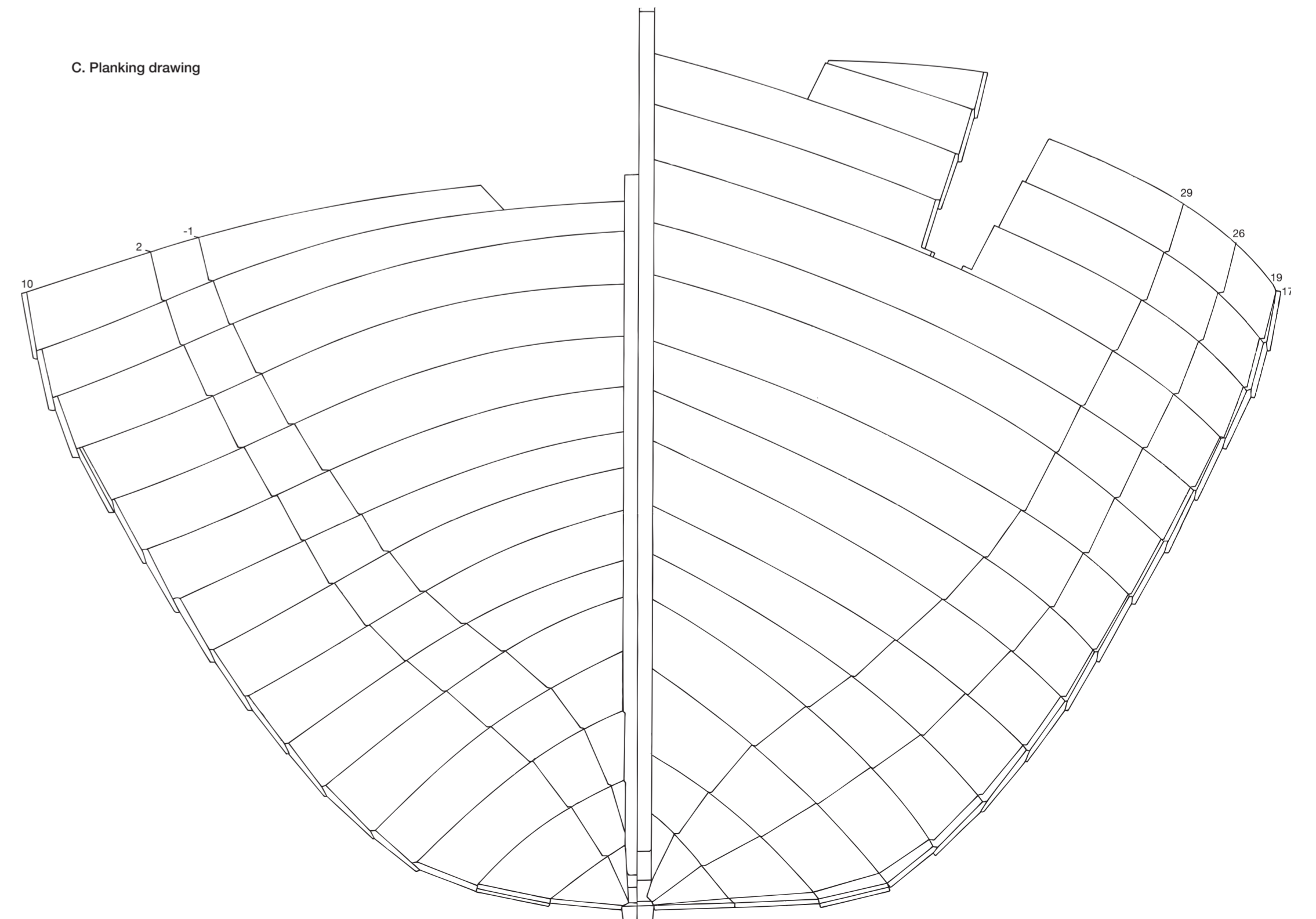

Legend

- Keel plank, stern- and stern-hooks, keelson with mast step, riders
- Bottom planks, bilge lath
- Shell planks, repair planks on the shell, windlasses, belaying rack, drain, sides of the castles
- Ceiling boards, deck planks of the castles
- Frames, deck beams, crossbeams, crossbeam knees, connecting beams, stringers, gangways, deck planks, stanchions supporting the castles, mast, pump, ladders
- Cross-cut wood
- Crossbeam number
- Frame number

Reconstruction drawings

- B. Cross-sections.
- C. Planking drawings of the upper edges of the strakes inside the forebody (frame S10 to stempost) and the forebody (frame S17 to stempost).

Scale



A. Interior of the starboard side

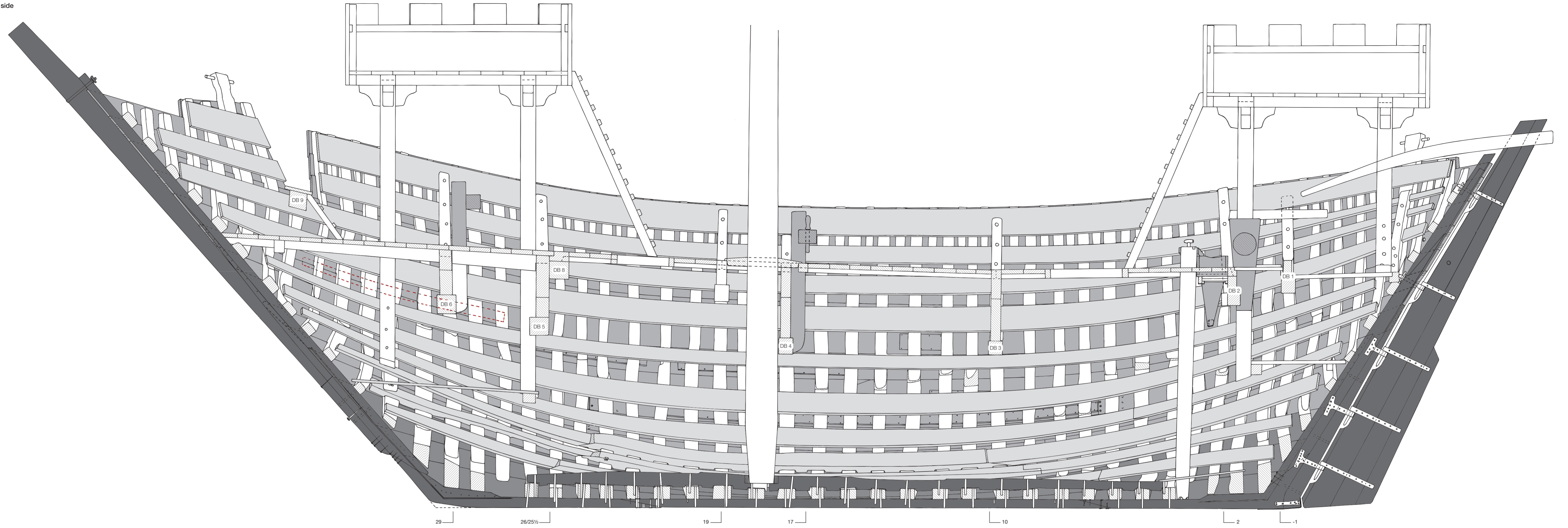

B. Exterior of the starboard side

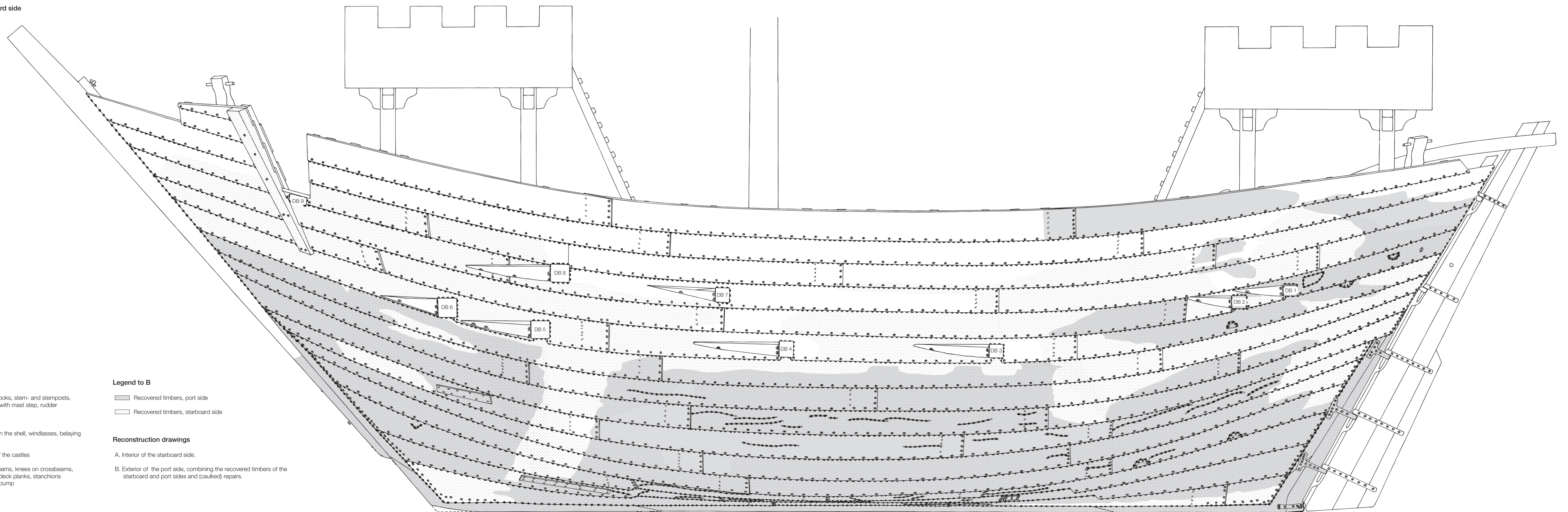

Legend to A

- Keel plank, stem- and stern hooks, stem- and sternposts, false stem and stern, keelson with mast step, rudder
- Bottom planking
- Shell planking, repair planks on the shell, windlasses, belaying rack, drain, sides of the castles
- Ceiling boards, deck planks of the castles
- Frames, deck beams, crossbeams, knees on crossbeams, connecting beams, stringers, deck planks, stanchions supporting the castles, mast, pump
- Cross-cut wood
- Later addition of shell clamb
- Crossbeam number
- Frame number

Legend to B

- Recovered timbers, port side
- Recovered timbers, starboard side

Reconstruction drawings

- A. Interior of the starboard side.
- B. Exterior of the port side, combining the recovered timbers of the starboard and port sides and (caulked) repairs.

Scale

